



Description

High Velocity Water Spray Nozzles are internal swirl plate type open nozzles designed for use in fixed water spray or deluge system for the fire protection application.

These nozzles produce solid uniform and dense core of high velocity water spray to effect fire control. Nozzles are normally used to cool the surface as well as for extinguishment.

High Velocity Water Spray Nozzles are typically used for Deluge protection of special hazards such as oil filled transformers, switch-gear, chemical process equipments, conveyor system and flammable liquid storage areas. The minimum desirable pressure to achieve a reasonable spray pattern is 3.5 Kg./sq.cm. (50 psi). The water distribution pattern is as shown in the graph in following pages giving maximum effective axial distance from the nozzle. The spray pattern shown is with indoor application. The system designer must consider wind velocity while designing the system for outdoor application. Field obstruction if any affecting the spray pattern of the nozzle must be considered.

The nozzle may be oriented in any position as deemed necessary to cover the hazard. 3.5 bar to 7 bar pressure at Nozzle is recommended for effective application requiring high velocity water delivery for rapid extinguishment of all fires by emulsification.

The Nozzles are having inbuilt Strainer, but still main pipeline strainer is required in the system. The Blow-off cap can be used to prevent the depositing of foreign material in the water way of the nozzle. Use of Blow-off cap is optional and not UL listed.

Maintenance

The spray nozzle must be handled with due care. For best results, the storage as well as any further shipment be made in original packing only.

Nozzle which is visibly damaged should not be installed. Use Teflon tape or soft thread sealant on the male thread of the nozzle.

It is recommended that the water spray system be inspected by an authorised technical personnel. The nozzle must be checked for corrosion, external and internal obstruction, blockage if any. The nozzle should be cleaned or replaced if required.

The system must be operated with optimum water flow at least three times in a year or as per the provision of NFPA/TAC or local authority having jurisdiction.

The owner is solely responsible for maintaining the water spray system and components therein, so that it performs properly when required.

Technical and Environmental Specification

Maximum Working Pressure	12 Bar (175 PSI)	
Effective Working Pressure	3.5 Bar To 10.5 Bar (50 - 150 Psi)	
End Connection	¾" Bspt (¾" Npt Optional)	
Materials	HV-AS Housing & Scroll Brass IS : 291 (Equivalent To Astm-B21)	
	Strainer - Copper HV-BS Stainless Steel CF8M (SS316)	
Included Water Spray Angle And K-Factor	Spray Angle	K-Factor
	75°	Metric (Us)
	80	22 (1.54)
	90°	18 (1.26)
	100°	32 (2.24)
	115°	26 (1.82)
120°	42 (2.94)	
Weight (Approx)	0.200 Kg	
Finish	Natural Finish	
	Nickel Chrome Plated (optional for HV-AS)	
Approvals	UL Listed	
Ordering Information	Specify K-Factor, spray angle, finish, model and end connection	

Sectional Details

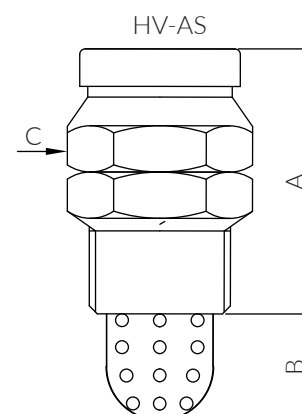

Nozzle factor & Spray angle	A	B	C A/F
K 22 X 75°	49	21	30
K 18 X 80°	44	21	30
K 32 X 90°	49	21	30
K 26 X 100°	55	21	30
K 23 X 120°	49	21	30
K 42 X 115°	49	21	30

Discharge Characteristics

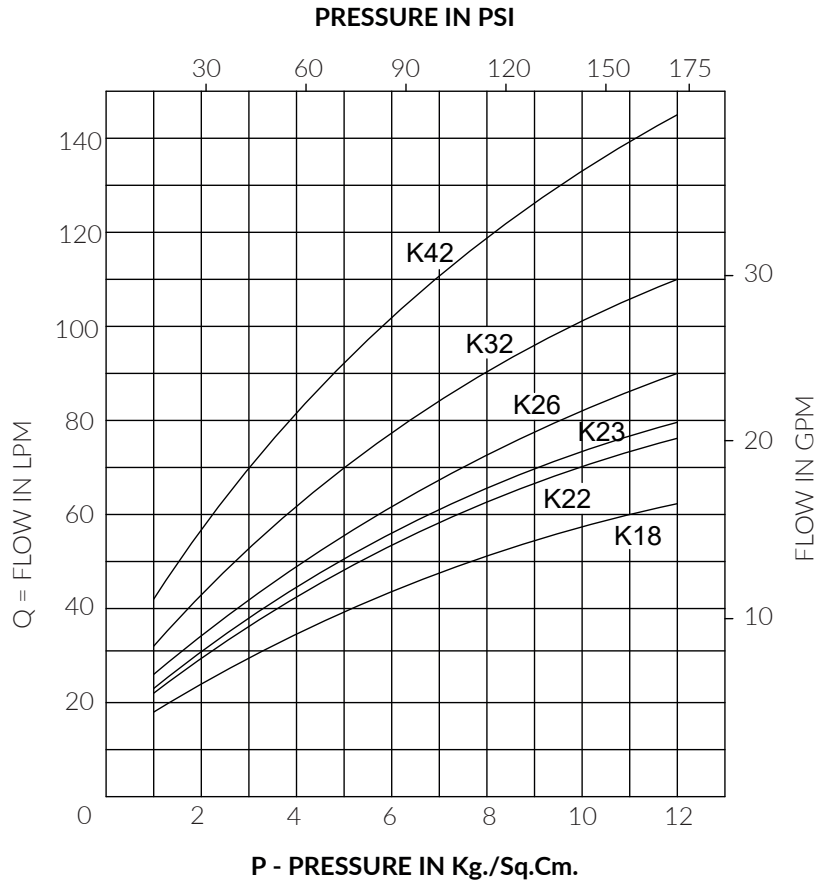

$Q = K \sqrt{P}$ where P is supply pressure in Kg/sq.cm., K = nozzle constant (K-factor) in metric.
 US K factor = Metric K factor \div 14.2745

Spray Pattern

K22 X 75°

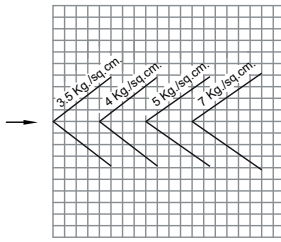

Spray Horizontal

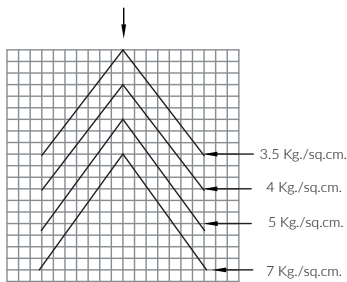

Spray Vertically Downward

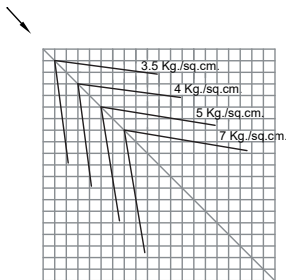

Spray At 75° Downward

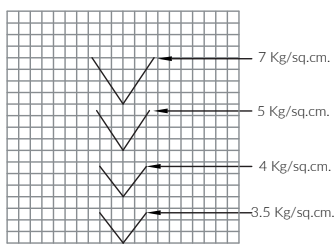

Spray Vertically Upward

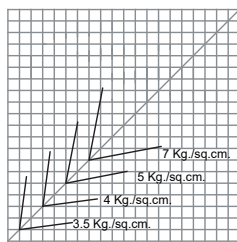

Spray At 45° Upward

K18 X 80°

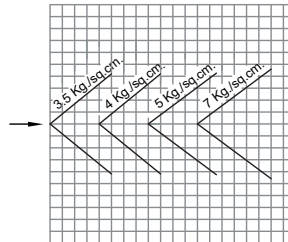

Spray Horizontal

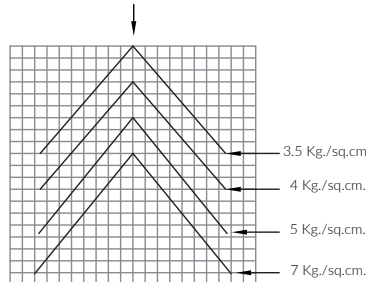

Spray Vertically Downward

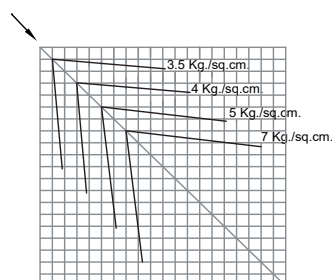

Spray At 75° Downward

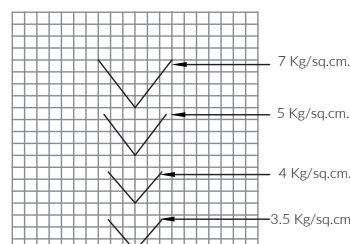

Spray Vertically Upward

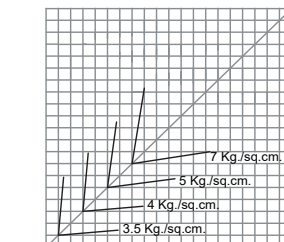

Spray At 45° Upward

K32 X 90°

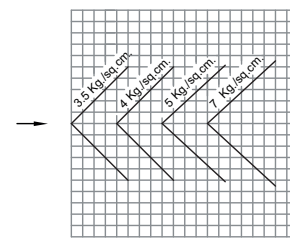

Spray Horizontal

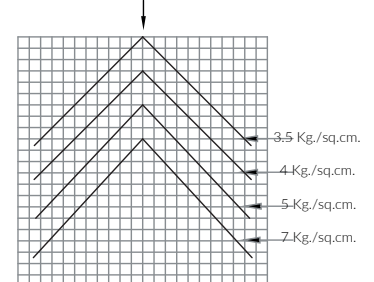

Spray Vertically Downward

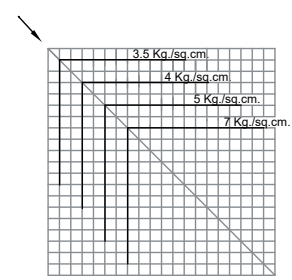

Spray At 75° Downward

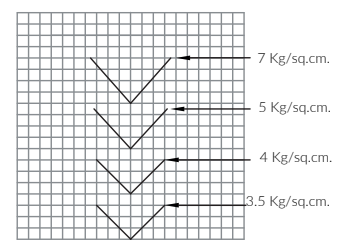

Spray Vertically Upward

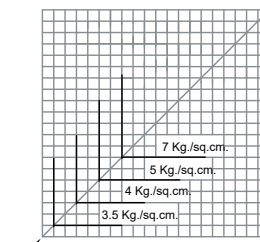

Spray At 45° Upward

Note : One square is 200 X 200 mm.

Spray Pattern

K42 X 115°

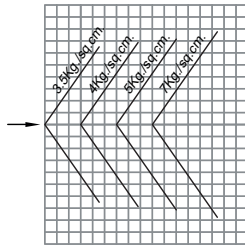

Horizontal

K23 X 120°

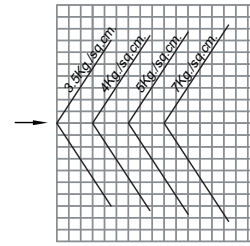

Horizontal

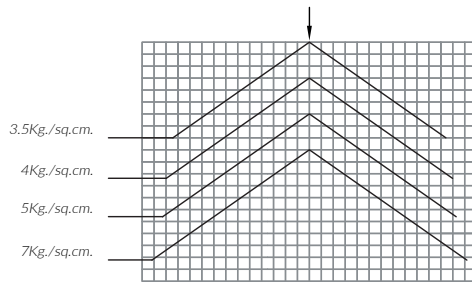

Vertically Downwards

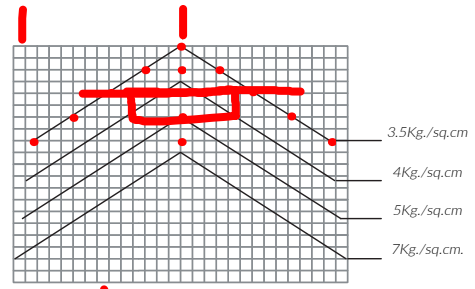

Vertically Downwards

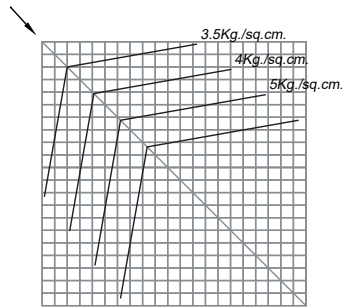

45 Deg. Downwards

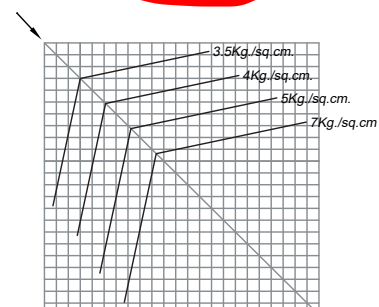

45 Deg. Downwards

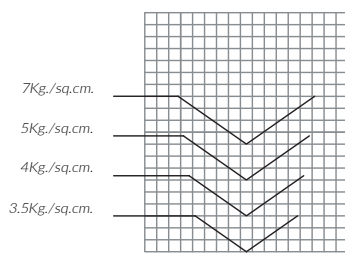

Vertically Upwards

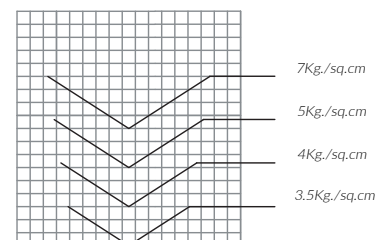

Vertically Upwards

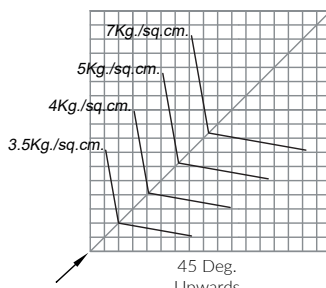

45 Deg. Upwards

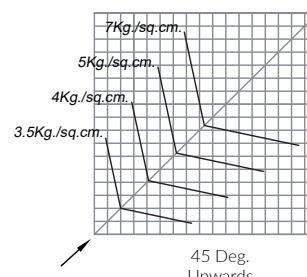

45 Deg. Upwards

Note : One square is 200 X 200 mm.

Spray Pattern

K26 X 100°

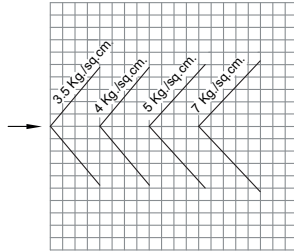

Spray Horizontal

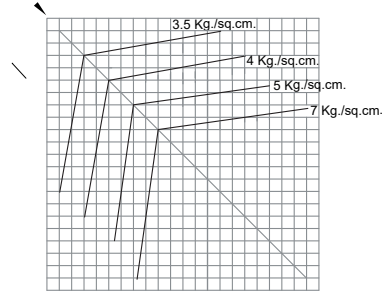

Spray At 45°
Downward

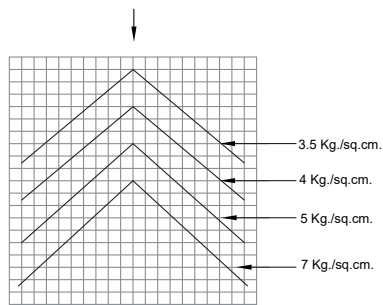

Spray Vertically
Downward

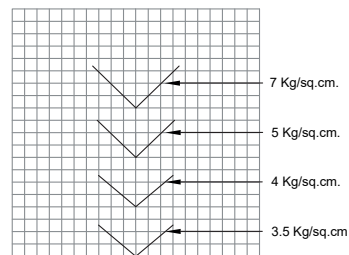

Spray Vertically
Upward

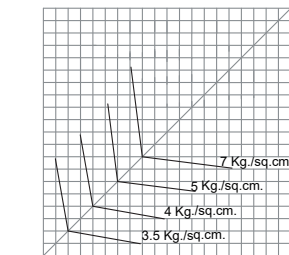

Spray At 45°
Upward

Note : One square is 200 X 200 mm.